



covrex.

Outstanding pool covers



Professional Catalogue 2021

SAFETY COVERS, SWIMMING POOL AND SPA EQUIPMENT



+32 16 553 770



info@covrex.com



www.covrex.com

TSPH
the swimming pool hub
●●●

Made in Belgium



Our production tools

At Covrex® we make the vast majority of our own products in our factories based in Aarschot. Our bespoke slats and drive systems are cut and manufactured in our different production workshops.



Design

Our integrated design office allows us to develop new and ever more innovative products, and to adapt our range of pool covers to our customers' specifications. Our designers are dedicated to all of your projects.

Manufacture

The production site and partial automation of the manufacturing process of our products allow us to ensure short delivery times. Our factory is equipped with a laser cutter, a folding machine and an automatic cutting machine for our slats.

Our professional clients as well as the happy pool owners are always welcome to visit our factory and showroom.



Our values



Respect

We show the same level of respect to our partners as well as to our colleagues. Every individual is unique and we operate in a spirit of cooperation and human values.



Partnership

Covrex® wants to create long-term partnerships, both with its customers and suppliers, through successful collaborations and win-win growth.



Excellence

We work hard to achieve excellence and are always open to any suggestions for improvement or innovation.

Nearly 20 years of experience of keeping you safe

2003

Creation of the Covrex® brand within LPW Pools

2006

Launch of the latest version of the Covrex® Classic slat

2017

The factory is damaged by a serious fire. Covrex® and LPW Pools use this opportunity to reinvent themselves and improve and modernise their production methods.

2020

Covrex® is part of the evolution of the group by joining TSPH (The Swimming Pool Hub) which includes Covrex®, LPW Pools and Walter Pool.

2004

Development of the first filled slat prototype. First pool cover with filled slats and flexible joints, patented worldwide.

2011

Launch of the Covrex® Solar slat

2018

Covrex® grows and becomes a separate company within the LPW Pools Group



OUR SLATS

1. Covrex® Classic
2. Covrex® Solar



OUR SLATS

Innovation, quality and safety

Thanks to our research team and our own assembly plant, Covrex® slats offer sleek design, are produced with the best materials and meet the strictest current standards.

Covrex® slats are available in four models:

Covrex® Classic: the strongest and most insulating filled slat on the market (patented).

Covrex® Solar: a polycarbonate heating slat with anti-algae properties.

Compatible with all swimming pools

Thanks to our big range of drive systems, Covrex® slats adapt to virtually any pool and are an ideal solution to cover new pools and renovations.

	Covrex® Classic	Covrex® Solar		
Slat	Filled slat	Polycarbonate slat		
Weight	7kg/m ²	3.4kg/m ²		
Benefits	Insulating and resistant	Heating, anti-algae		
Colours	○ ○ ○ ○ ○	● ● ● ○		
Rolled-up diameter For a 10m pool	425 mm (114 mm axle)	503 mm (114 mm axle)		
Special shape	✓	✓		
Warranty	5 years	5 years		



Covrex® Classic

INSULATING AND SECURE SWIMMING POOL COVER

In 2003, after realising that no cover on the market met our customers' requirements for safety, durability and insulation, our engineers designed the Covrex® Classic automatic swimming pool cover.

The Covrex® Classic slats were immediately a great success in the swimming pool market. Growing demand quickly crossed borders to reach many parts of the world. In 2006, a new version of the Covrex® Classic slat was created to further improve its strength, insulation and ease of maintenance.

Providing maximum security is one of the objectives of Covrex®. To achieve this, our covers have been developed according to French safety standards NF P90-308 relating to swimming pool covers, with which they are fully compliant and even exceed up to three times. As a result, Covrex® pool covers are perfectly secure for both adults and children. In addition, Covrex® Classic slats received ISO 1183 certification following a large number of tests: thermal co-efficiency, expansion, elasticity (tear/break) and UV tests using xenon gas and other substances.

Benefits of patented Covrex® Classic covers and their systems



Insulation

Covrex® Classic slats provide the best insulation on the market, with a thermal transmission coefficient of only 4.85 W/(m².K).
Traditional hollow slats: 5.24 W/(m². K)



Resistance

Filled Covrex® Classic slats are specifically designed to withstand hail, frost and high temperature variations (-40°C to +70°C). Our systems are all made from 316L stainless steel (A4) to prevent rusting.

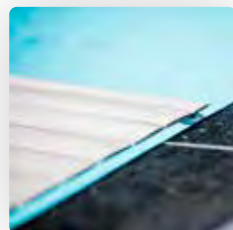

Maintenance

Covrex® Classic slats do not use a traditional hinge but are coextruded with a flexible, perfectly smooth joint to prevent algae from clinging to them. The slats therefore do not have a hollow chamber where algae and dirt could accumulate.

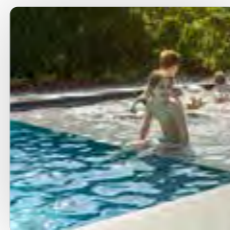

Safety

Fully compliant with the French safety standards NF P90-308 for swimming pool covers, our covers even exceed by up to three times the recommendations of these standards when installed with the recommended options.



Shape

With their solid slats, Covrex® Classic covers adapt to all swimming pool shapes, including those that are curved as they don't have end caps at the end of the slats and can be custom-cut with a jig saw.

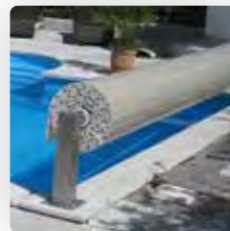

Space saving

The Covrex® Classic cover has a rolled-up diameter up to 50% smaller than a traditional cover, maximising the space for swimming in the pool.

Available in four colours



Arctic Blue
RAL 5012



Cream White
RAL 9001

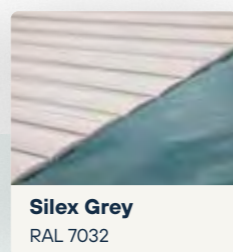

Silex Grey
RAL 7032

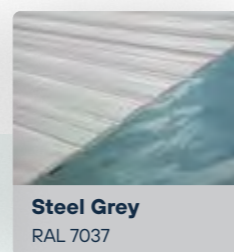

Steel Grey
RAL 7037

The connections between the slats of Covrex® Classic covers are always grey. Our laboratory tests have shown that silex grey polyurethane (the material used for the connections) has the best resistance to UV and aging. Discover these four colours at the outdoor pools at the Covrex® showroom in Aarschot, in Flemish Brabant.

Insulation

Thanks to their impressive insulation capacity (insulation coefficient of 4.85 W/(m². K)), Covrex® Classic filled slats help keep the heat in the pool. This means that pools equipped with a Covrex® Classic cover have a longer swimming season and minimise heat loss during colder nights and days.

The best insulation on the market

All traditional swimming pool covers are made of hollow slats or chambers that get filled with moist air. This moist air greatly reduces the insulation coefficient. In addition, these traditional hollow slats are connected by hinges, which cause additional heat loss.

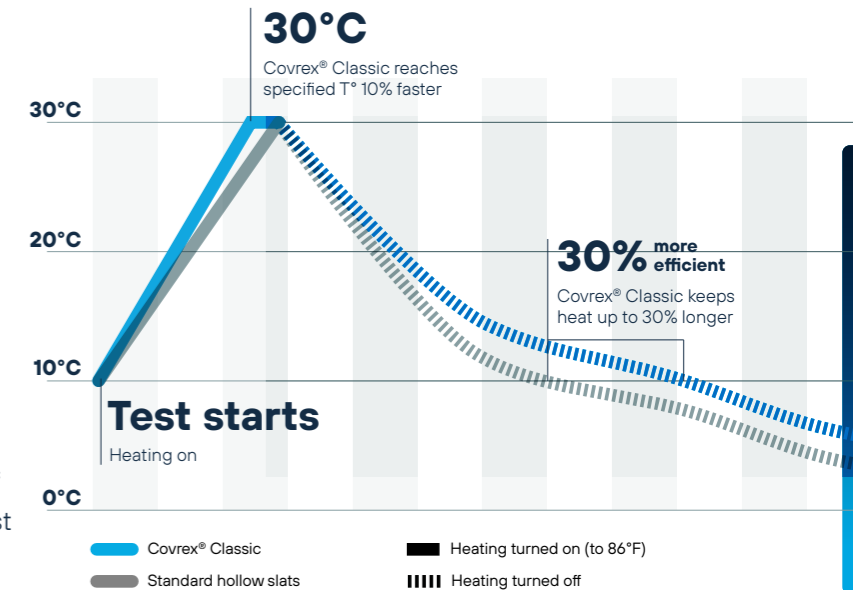

Weather and hail resistance



After the hail test, conducted by an external and independent laboratory.
On the left: standard hollow slats
On the right: Covrex® Classic slats

It took over five years of research to create Covrex® Classic slats. Compared with traditional covers, regularly damaged due to hail, frost, or extreme weather conditions, Covrex® Classic slats offer unmatched resistance to bad weather all year long and any damage related to hail or frost is even covered by our warranty!

Thanks to the high-quality materials used, our Covrex® covers are easily able to withstand extreme weather conditions and maintain their flexibility up to -20°C. This means Covrex® covers can remain on the water during the winter without any additional protection or lower the water level. This means there is no need to install a

winter system or bubble cover. And vice versa, in extremely hot temperatures, while traditional covers can bend and deform, Covrex® Classic slats keep their shape up to 70°C with no problem.

And when autumn arrives and the trees lose their leaves, Covrex® covers keep the pool clean, with their flexible joints preventing leaves and dirt from entering the pool by slipping between hinges.

Safety

One of our missions at Covrex® is to provide maximum security. To achieve this, our covers were developed in line with the French safety standards NF P90-308 relating to swimming pool covers, with which they are fully compliant and even exceed up to 3 times. As a result, Covrex® pool covers are perfectly safe for both children and adults.

It is possible to add safety hooks to the covers to make the installation even more safe, to the extent that the cover could support the weight of several adults without risk of them falling in or the cover breaking. A handrail is also available as an option.

Some swimming pools (such as those from LPW Pools) have a safety ledge for even more safety.



Anti-algae properties, easy maintenance

Covrex® Classic slats do not have traditional hinges. They are co-extruded with a flexible joint so that dirt and algae cannot cling to the cover or get into the swimming pool. This structure also makes it easier to take care of the cover: it can even be cleaned when the pool is open using a high-pressure cleaner (at a minimum distance of 50 cm).

The flexible PU joint is extremely resistant and durable. This has been confirmed by laboratory

tests, and the results, as well as the comparison with a traditional slat, are shown below, with our slats proving to be more than three times more resistant.

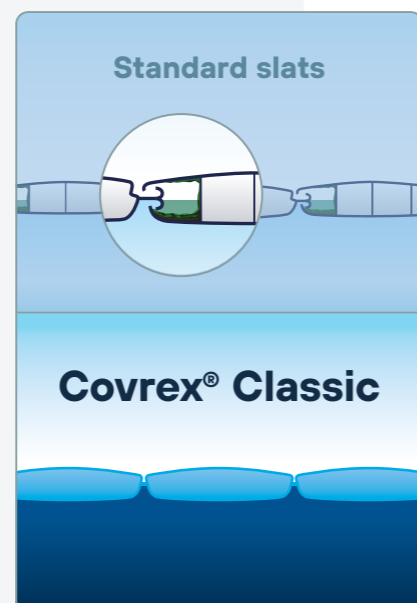
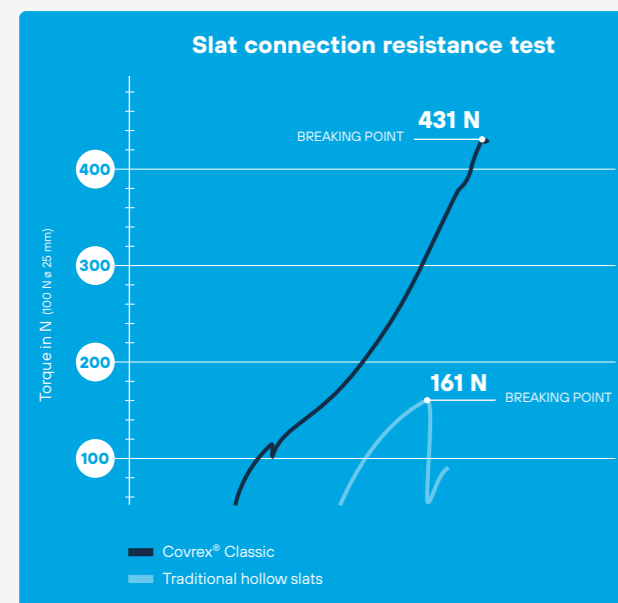

Style

Covrex® Classic covers are the only foam filled slats with a flexible joint, offering increased resistance as well as a perfect finish, including pools with curved shapes. For swimming pools of different shapes, the installer will cut the slats directly on site so that the cover perfectly fits the curves of the pool.

With Covrex® Classic covers, gone are the days of stair-shape covers.



Covrex® Classic rounded cut

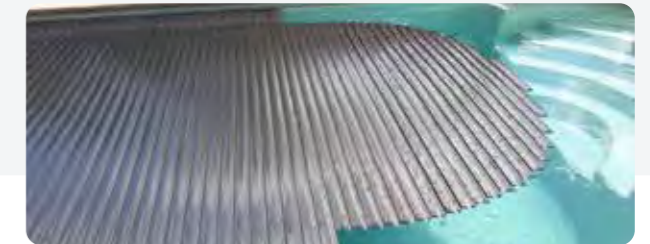

Traditional stair-cut covers with hollow slats

Optimised swimming surface

Thanks to its compact design, the Covrex® Classic cover has the smallest rolled-up diameter on the market. With a 50% space saving compared to traditional covers, it provides more space in the pool for maximum swimming space.

For example, the rolled-up diameter of your cover in a 12-metre long pool will be only 50 cm, while that of a traditional cover would be between 70 and 110 cm.

Axle diameter

Length	114 mm axle	141 mm axle
0m (base)	114 mm	141 mm
3 m	270 mm	280 mm
8 m	375 mm	420 mm
10 m	425 mm	465 mm
12 m	465 mm	500 mm
14 m	505 mm	535 mm
16 m	535 mm	560 mm
18 m	575 mm	585 mm
20 m	600 mm	620 mm
25 m	-	700 mm



Technical information

Co-extruded pool cover with filled slats and flexible polyurethane joints.

Year launched: 2006

Warranty: 5 years, including hail and frost damage (see warranty conditions)

Compliance: French safety standard NF P 90-308

Dimensions: width: 19.6 mm per slat, custom length (maximum 12.50 m)

Mechanical features

Interior: Expanded PVC foam

Exterior: Compact PVC

Flexible joints: polyurethane (TPU)

Tear propagation resistance of the PUR hinge according to ISO 34/1: ≥ 55 N/mm

Tensile strength of the hinge according to ISO 527 (measured on a 25 mm wide profile sample at a speed of 50 mm/min: ≥ 150 N

Coefficient of linear dilation according to DIN 53752: ca. $0.8 \times 10^{-4} 1/^\circ\text{K}$

Xenotest 1200 for artificial ageing, cycle 102: 18 min, 4000 h according to ISO 489

Grey scale: > level 3

Thickness: 14 mm

Weight: approx. 7.0 kg/m²

Thermal characteristics

Temperatures: min. -40°C and max. +70°C

When being opened and closed, the cover must always be free of snow and ice.

In the event of a large temperature difference between the outside air and the swimming pool water, the slats may bend slightly at the ends. However, this phenomenon is minimal, brief, and completely disappears when this temperature difference ends.

Chemical characteristics

pH level tolerated in the water: between 7.0 and 7.4

Maximum chlorine level: 2 mg/l

After a chlorine shock treatment, keep the cover open for 24 hours and the pool filter turned on.

If the water is treated with salt electrolysis, connect the

cover to the electrolyser to stop (or significantly decrease) chlorine production when the cover is closed to avoid over-chlorination. Any damage caused by over-chlorination will not be covered by the warranty. Although extruded with an anti-UV protective layer, the joints are likely to turn yellow over time.

Maintenance

It is essential to clean your cover regularly in order to keep it in a good condition. You can use a high-pressure cleaner (max. temperature of 60°C at a minimum distance of 50 cm). We recommend using a cleaning product for swimming pool covers. It is prohibited to use sharp or rough materials and tools to clean the cover.

To avoid the build-up of dirt on the smooth surface of the slats, we recommend brushing the cover regularly. The presence of dirt on the smooth surface of the slats contributes to the development of algae.

Branches, leaves and other dirt, as well as any snow or ice, need to be removed from the cover before it is used.

Limestone deposits on the cover can be cleaned with an anti-limestone product in the water.

Assembly

Usage instructions are available on request by emailing service@covrex.com or through our website www.covrex.com

Laboratory resistance tests

See the resistance tests and comparisons with traditional hollow slats via the following links:

Tensile test:

<https://covrex.com/v/connection>

Shock resistance:

<https://covrex.com/v/hail>

Accelerated ageing:

<https://covrex.com/v/life>

Safety (with safety hooks):

<http://covrex.com/v/kids>



Covrex® Solar

SOLAR AND ANTI-ALGAE POLYCARBONATE COVER

Based on Covrex® expertise acquired over many years in the world of solar swimming pool covers, Covrex® Solar slats, made from polycarbonate, have an ultra-strong structure and first-rate performance. All this plus a stunning design to boot!

Polycarbonate has long been known for its strength. This extremely shock-resistant polymer has a very long lifespan.

To withstand UV rays, Covrex® Solar slats have a lined top layer. Specifically treated to resist UV rays, this lining is not extruded in the massa and has an even longer lifespan.

Benefits of Covrex® Solar covers and their systems



Hail and shock-resistant

Unlike traditional PVC solar covers, which are not very resistant to hail, Covrex® Solar polycarbonate slats are up to 16 x more shock- and impact-resistant. Tested according to Swiss VKF standards, they achieve the best result (Class 4), equivalent to the shock produced by the fall of an object the size of a tennis ball, at a speed of 110km/h and a temperature below 0°C.



Safety

Covrex® Solar slats meet the NFP90-308 safety standard and can be installed as a safety cover.



Anti-algae

Covrex® Solar slats are extruded to prevent the formation of algae. Having this structure directly integrated into the slat profile allows the slats to stay clean for longer by moving water through the hinges, which prevents algae from clinging and makes it difficult for them to spread.



Energy savings

Covrex® Solar covers save a significant amount of energy and require fewer chemicals and less maintenance. Thanks to these savings, the investment is quickly profitable.

Energy saving: Equipped with a Covrex® Solar cover, a swimming pool requires less heating.

Water treatment product savings:

Covrex® Solar slats prevent the build-up of dirt, algae and microorganisms in the pool. Treating the water therefore requires only a small quantity of chemicals (chlorine/pH/anti-algae). In addition, the opaque lower layer of the slats prevents photosynthesis as the sun's rays do not enter the pool.

Cover maintenance product savings:

Covrex® Solar slats are extremely durable and can be cleaned with a high-pressure jet.

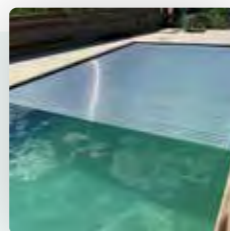

Ultimate transparency

The Covrex® Solar Pearl slat is a completely transparent polycarbonate mono-extrusion. This transparency means you can enjoy your swimming pool, even with the cover on.

Available in four finishes



Solar Aluminium

Unlike traditional solar covers, the innovative structure of Covrex® Solar Aluminium slats hides possible condensation present in the hollow slats.

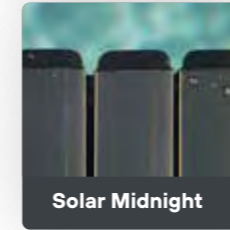

Solar Midnight

With the same benefits as the aluminium version, Covrex® Solar Midnight slats have a black finish with a beautiful golden shine. Guaranteed to impress.



Solar Blue

The colour of the Covrex® Solar Blue slats gives the impression of great depth while staying clean and safe.



Pearl

Covrex® Solar Pearl slats stand out for their complete transparency. Perfect to make the most of indoor pool lighting, they are also heating when used on an outdoor pool.

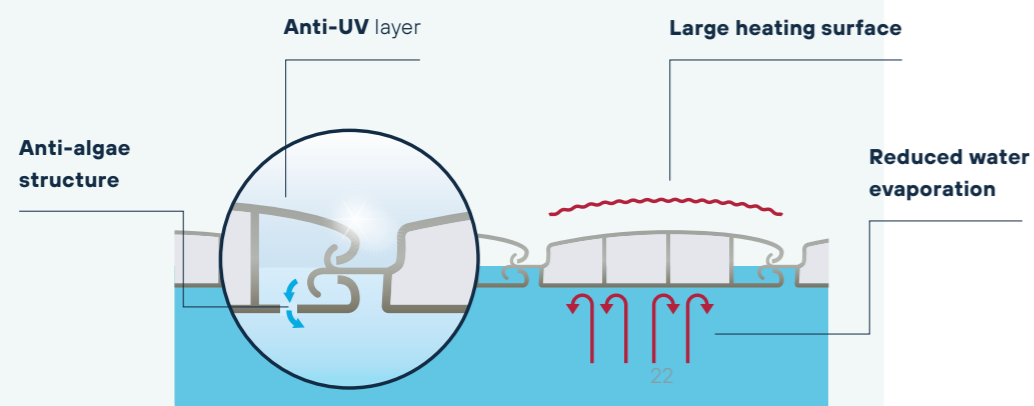



CONTROL PANELS

Covrex® Control panels

At Covrex® we create our own electrical cabinets (control panels) to meet the needs of our systems and customers. These range from the most basic to the most complex models, and manage almost all the functions of the pool.

Developed and designed in our workshop, they can be adapted as needed. Covrex® customers are thus assured of having, as always, a high-quality product.

We have three models of electrical cabinet:

CoverControl: the simple and standard panel supporting the pool cover and an additional function (e.g. electrolysis).

PoolControl^{mini}: controls the pool cover and the various light spots present in the pool.

PoolControl S: the most complete electrical panel, able to control almost all the systems present in a pool and even allowing the use of variable pumps (optional).

In addition to these three cabinets, Covrex® offers **Pool Connect:** A multi-function connection. It allows all the technical connections of the pool to be grouped together in a waterproof box placed in the pool or next to it.

	CoverControl	PoolControl ^{mini}	PoolControl S
Supply	230v	230v	230v (3-phase optional)
Cover	✓	✓	✓ (programmable)
Cover speed	-	-	✓
Filtration	✓	✓	✓ (bi-hourly)
Lighting	-	✓	✓ (auto/manual)
Water level	-	-	✓
Water temperature	-	-	✓
Antifreeze function	-	-	✓
Variable pump	-	-	✓ (optional)
Key cupboard	✓	✓	✓
Remote controlled	✓	✓	✓
Touch screen	-	-	✓
Open source	-	-	✓

Top Quartz

CSY001

Max. pool length
 Max. badlengte
 Longueur max. piscine

15 m

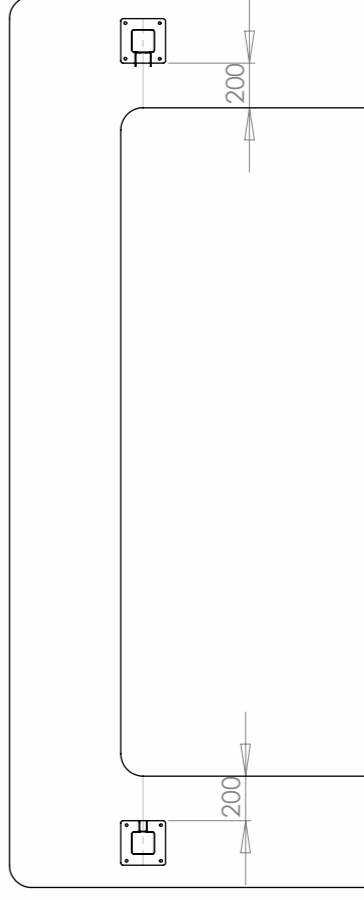
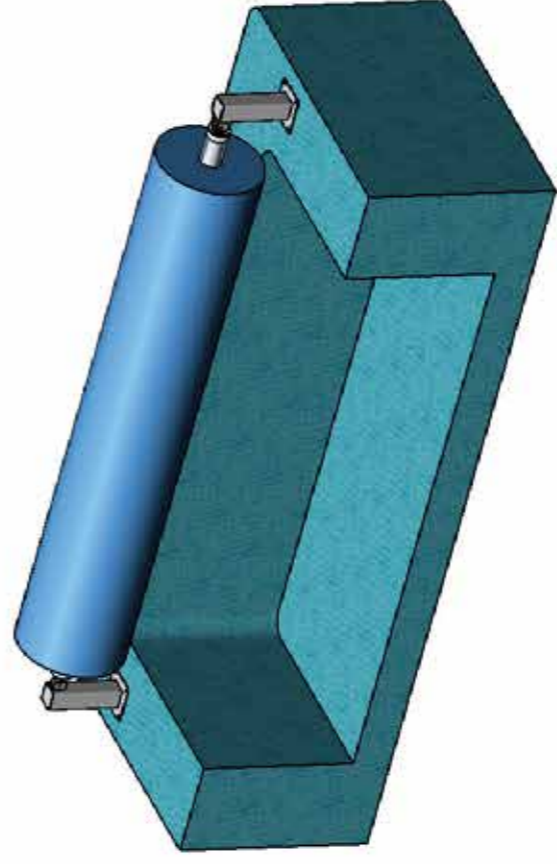
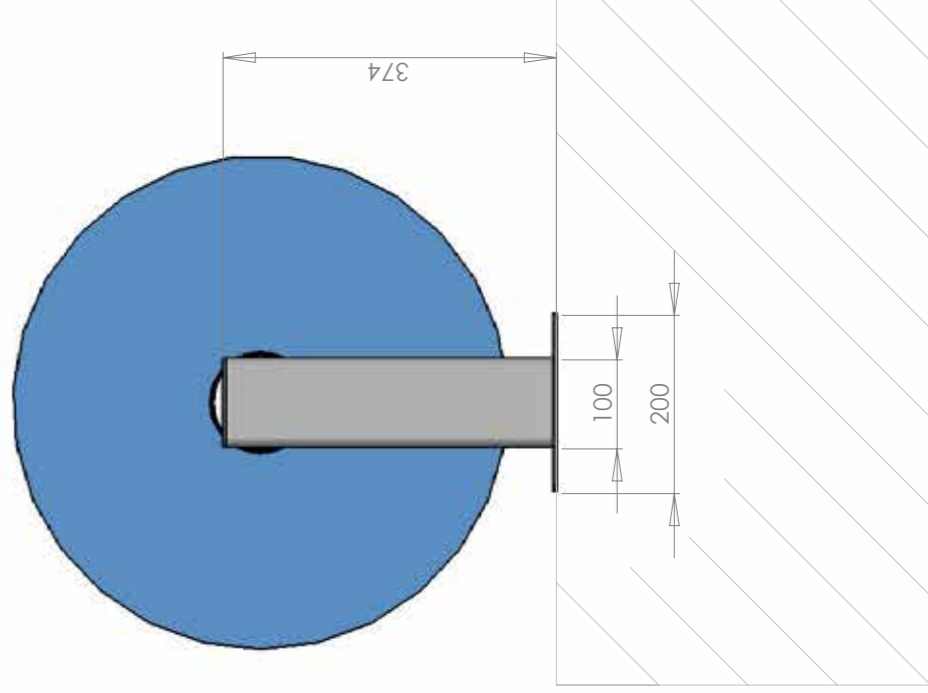

REF.	CSY001	 COVREX.
NL	Standaard Opbouw	www.covrex.com info@covrex.com
F	Hors Sol Standard	Tel : +32 16 55 37 70 Fax: +32 16 62 25 40
UK	Standard Top Mount	Doc. version : TD.CSY001.2.1
D	Standard Oberflurssystem	Date : 01/01/2015

TOLERANCES: LINEAR: +/- 2 % ANGULAR: +/- 2 % DO NOT SCALE DRAWING

DIMENSIONS IN MILLIMETERS

SHEET 1 OF 2

Drawing by Kontra Markta

Top Onyx

CSY002

Max. pool length
Max. badlengte
Longueur max. piscine

11 m

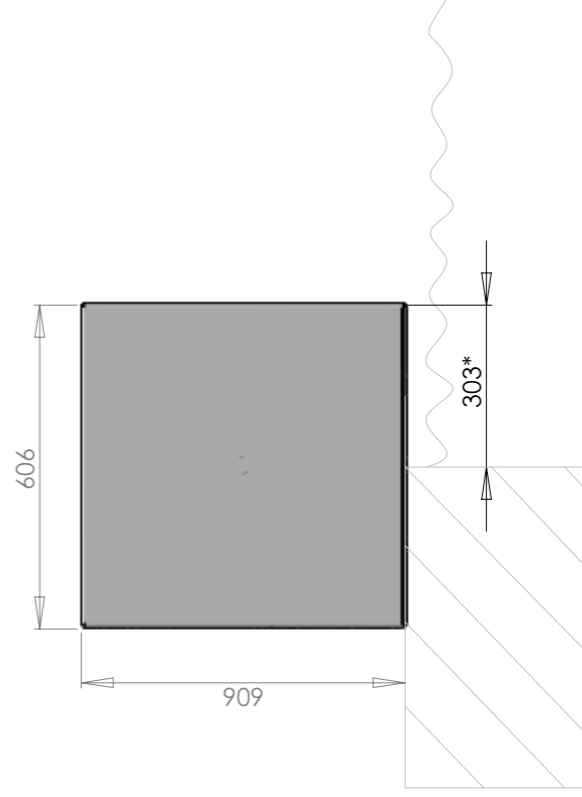

*** NOTE:**

Dimension only valid if straight pool corners (90°)

Afmeting enkel geldig indien de hoeken van het zwembad recht zijn (90°)

Dimension seulement valides en cas de coins de piscine droits (90°)

Mass nur gültig wenn die Winkel gerade sind (90°)

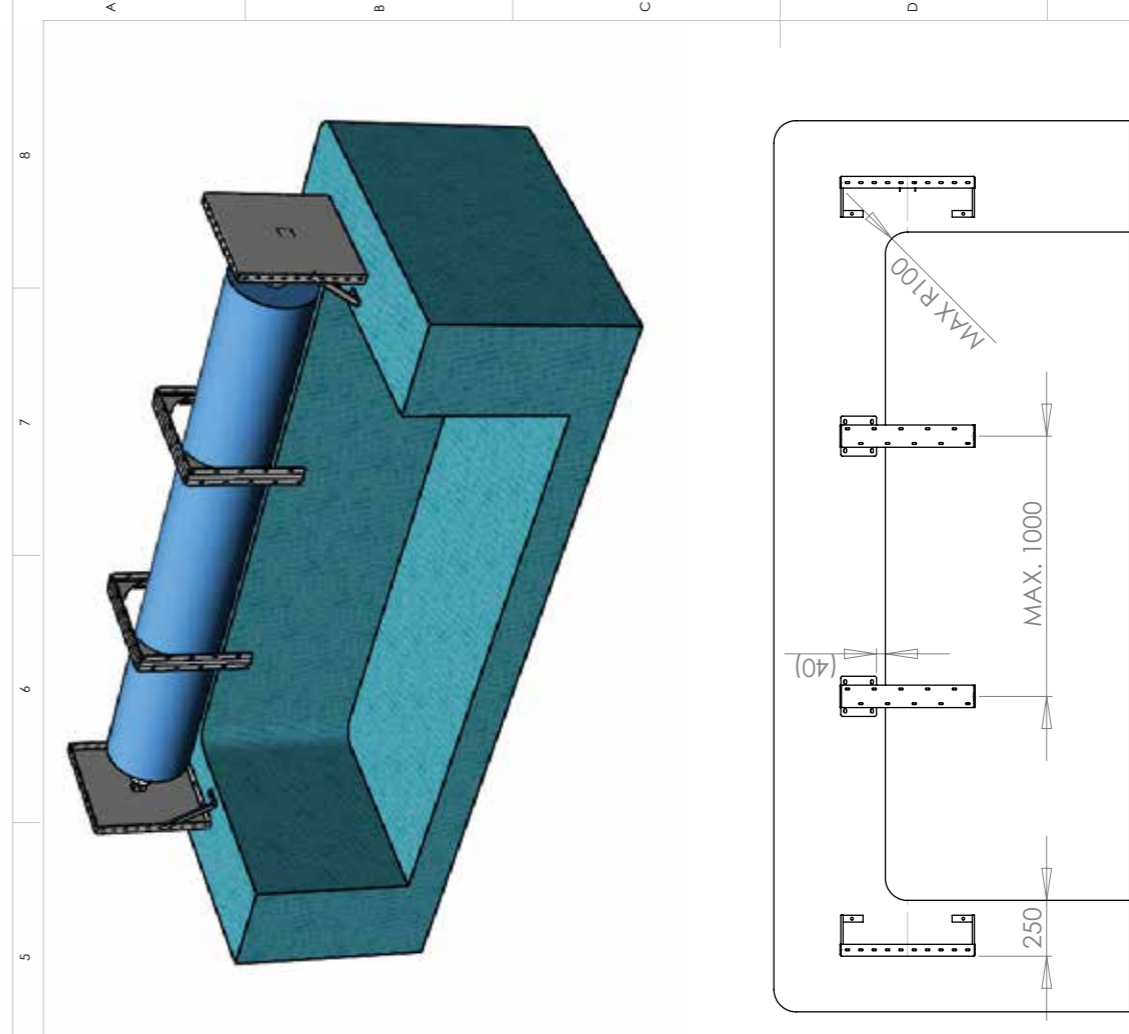

REF. CSY002

NL Opbouwkast

F Caisson Hors Sol

UK Top Mount for Casing

D Oberflurssystem für Verkleidung



www.covrex.com info@covrex.com

Tel : +32 16 55 37 70 Fax: +32 16 62 25 40

Doc. version : TD.CSY002.1.4

Date : 14/01/2016

TOLERANCES: LINEAR: +/- 2 % ANGULAR: +/- 2 % DO NOT SCALE DRAWING

%

4

3

2

1

SHEET 1 OF 2

Under Flow

CSY004

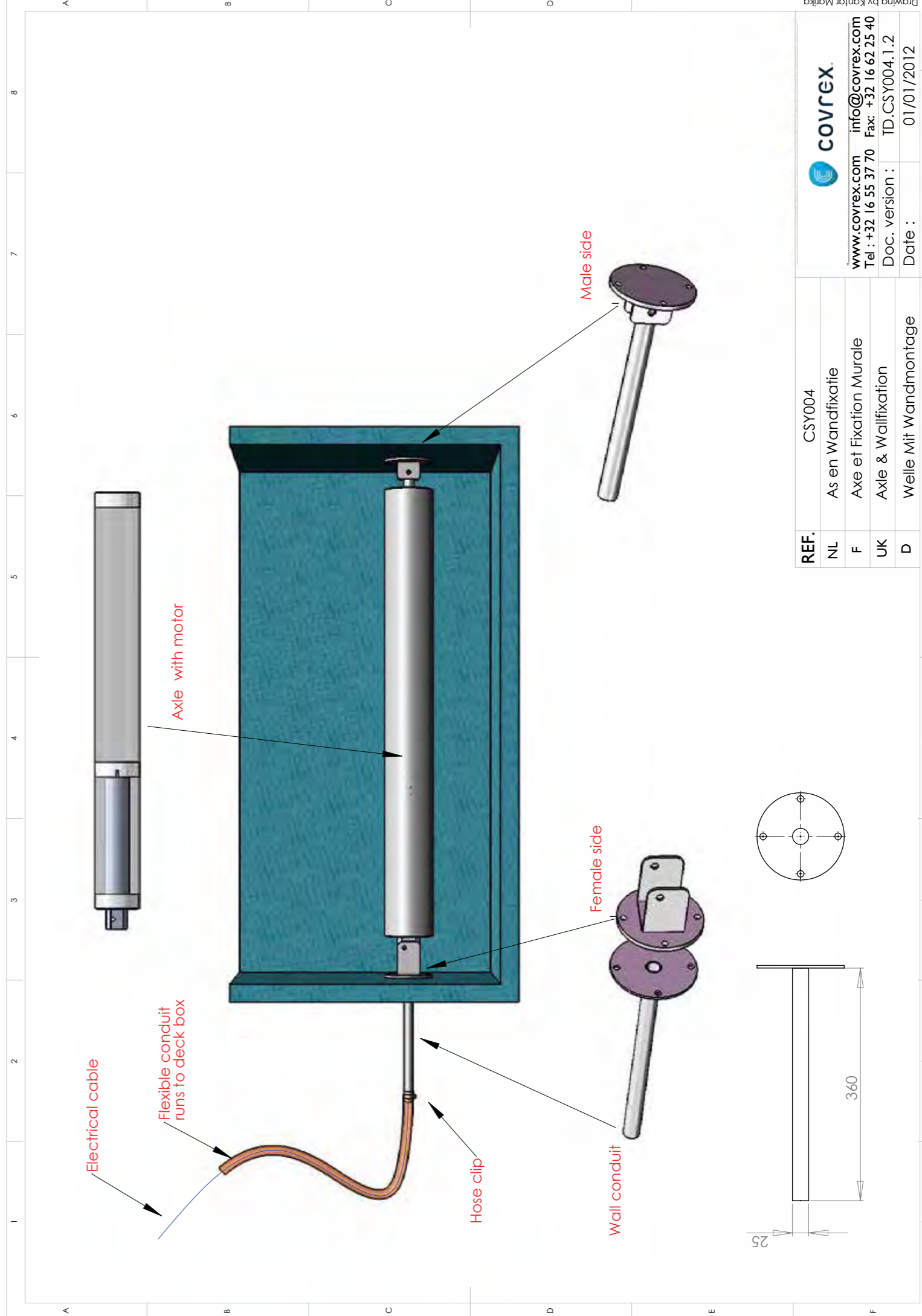

REF.	CSY004
NL	As en Wandfixatie
F	Axe et Fixation Murale
UK	Axle & Wallfixation
D	Welle Mit Wandmontage

www.covrex.com	info@covrex.com
Tel : +32 16 55 37 70	Fax: +32 16 62 25 40
Doc. version :	TD.CSY004.1.2
Date :	01/01/2012

TOLERANCES:	LINEAR: +/- 2 %	ANGULAR: +/- 2 %	DO NOT SCALE DRAWING
DIMENSIONS IN MILLIMETERS			
SHET 1 OF 1			

Drawing by Kantor Markta

Max. pool length
 Max. badlengte
 Longueur max. piscine

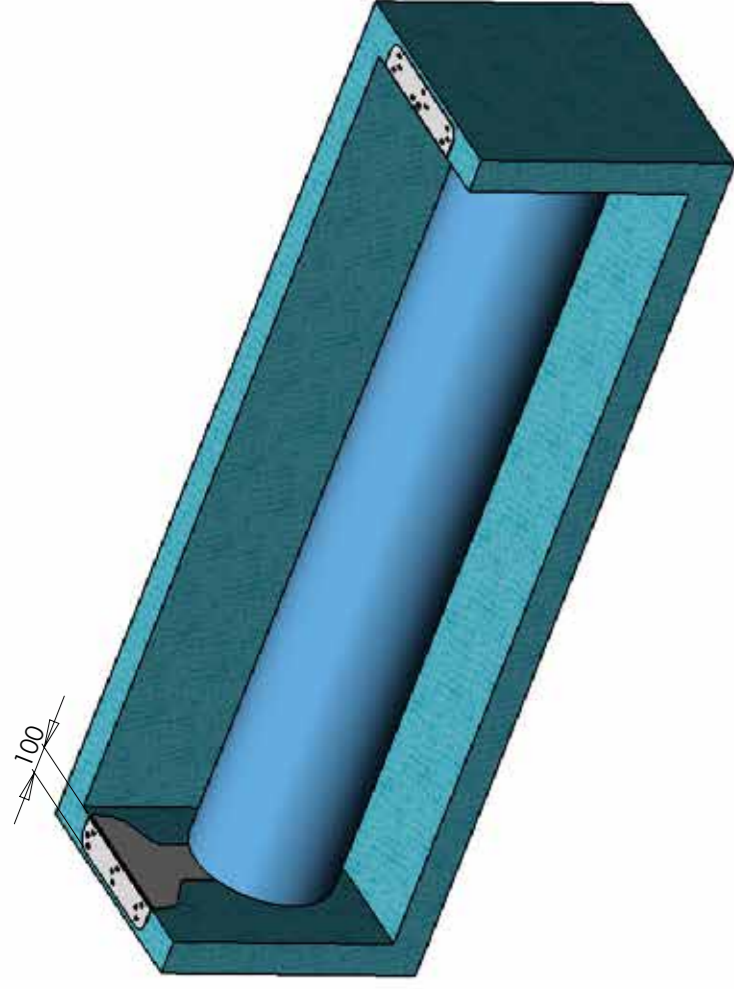
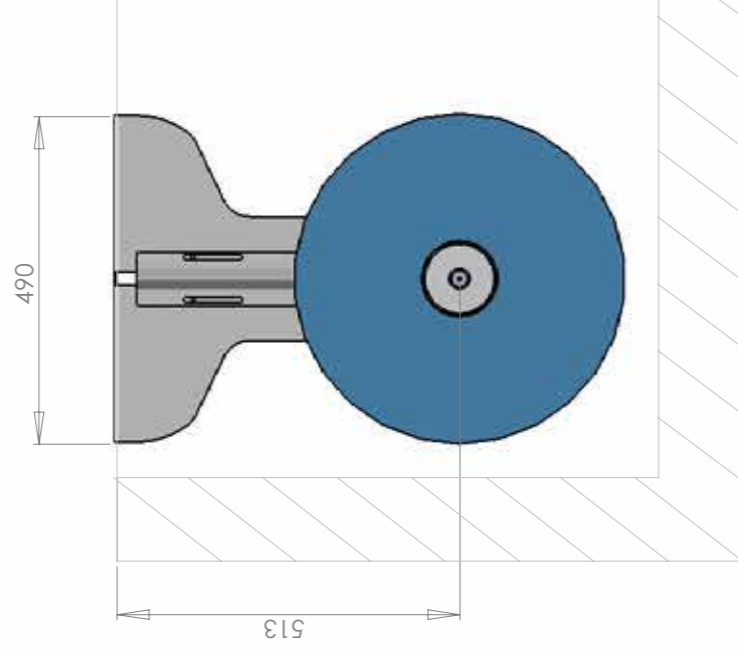

REF.	CSY004.2
NL	As met zijplaat
F	Axe et flasques murales
UK	Roller with wall fixing plates
D	Welle mit horizontaler Befestigung



www.covrex.com info@covrex.com
 Tel : +32 16 55 37 70 Fax: +32 16 62 25 40
 Doc. version : TD.CSY004.2.0
 Date : 01/01/2015

TOLERANCES: LINEAR: +/- 2 % ANGULAR: +/- 2 % DO NOT SCALE DRAWING

DIMENSIONS IN MILLIMETERS

SHEET 1 OF 2

Drawing by Kantor Markta



REF.	CSY004.2
NL	As met zijplaat
F	Axe et flasques murales
UK	Roller with wall fixing plates
D	Welle mit horizontaler Befestigung



www.covrex.com info@covrex.com
 Tel : +32 16 55 37 70 Fax: +32 16 62 25 40
 Doc. version : TD.CSY004.2.0
 Date : 01/01/2015

TOLERANCES: LINEAR: +/- 2 % ANGULAR: +/- 2 % DO NOT SCALE DRAWING

DIMENSIONS IN MILLIMETERS

SHEET 2 OF 2

Drawing by Kantor Markta



Outstanding pool covers



Ecuador:

PoolCoverPro

Álvaro Velasco

alvarov@hidrotherm.com / +593-99-6513608

Centro Comercial Home Design Cumbaya

Local #22

Instagram @PoolCoverPro

 www.covrex.com

TSPH
the swimming pool hub
